

FEATURES

- ✓ Wide Operating Temperature Range
- ✓ Standard 9x14mm Package
- ✓ Rugged Hermetically Sealed Package
- ✓ Mil-Std-202 Compliant

Voltage Controlled Oscillator

#blileytakesyoufurther

Description

Voltage Controlled Oscillators are designed to meet the rigorous demands of Military Standards as well as provide long life to OEM equipment manufacturers. Bliley Engineers Concurrent Design philosophy provides robust designs which are economical as well as reliable for long-term life. Applications consist of SATCOM, TELECOM, Military and Instrumentation.

Block Diagram



Part Number Configuration

BVCS - M - - - - T

<u>Footprint</u>	<u>Center Frequency</u>	<u>Supply Voltage</u>	<u>Output Control</u>	<u>Frequency vs. Temperature</u>	<u>Operating Temperature</u>	<u>Output Type</u>	<u>EFC</u>
9: 9x14mm(6pad) A: 9x14mm(4pad)	1MHz to 200MHz	D: 3.3V E: 5V	N: N/A E: Enable T: Tristate	A: ±25ppm B: ±50ppm D: ±20ppm E: ±10ppm	B: -20°C to 70°C C: -40°C to 85°C D: -55°C to 125°C	C: CMOS/TTL D: HCMOS	A: ±25ppm B: ±50ppm C: ±100ppm

*Not all combinations of options may be possible
**Other options may be available

Performance Specifications

Parameter	Conditions	Values			Unit
		MIN	TYP	MAX	
Frequency Range		1		200	MHz
Frequency Stability					
vs. Temperature	See Options (Max) Referenced to +25°C	±10, ±20, ±25, ±50			ppm
vs. Load	5% Change			±1	ppm
vs. Supply Voltage	5% Change			±1	ppm
Aging	1 st Year			±2	ppm
Supply Voltage	Option D	3.13	3.3	3.47	Vdc
	Option E (1MHz-160MHz)	4.75	5	5.25	Vdc
Current Consumption	1MHz			10	mA
	40MHz			30	mA
	200MHz			50	mA
Output Control	Enabled Low Disabled High				
Electronic Frequency Control					
Voltage Range	@3.3V	0.15		3.15	Vdc
	@5V	0.5		4.5	Vdc
Center Voltage		Vdd/2			
Frequency Range	See Options (Min)	±25, ±50, ±100			ppm
Slope		positive			
Input Impedance		100			kΩ
Linearity		10			%

Performance Specifications

Parameter	Conditions	Values			Unit
		MIN	TYP	MAX	
Output Characteristics		MIN	TYP	MAX	
High Output Level	Logic "1"	90% Vdd			dBm
Low Output Level	Logic "0"			10% Vdd	dBm
Rise/Fall Time				10	nSec
	For 1Mhz		2.8		nSec
	For 100-200MHz		0.55		nSec
Duty Cycle		40	50	60	%
Load			15		pF

Parameter	Conditions	Values			Unit
		MIN	TYP	MAX	
Phase Noise		MAX	MAX	MAX	
Phase Noise (@ 25°C)	Offset	100 MHz	125 MHz	200 MHz	
	10Hz	-85	-80	-67	dBc/Hz
	100Hz	-115	-110	-98	dBc/Hz
	1kHz	-140	-135	-130	dBc/Hz
	10kHz	-160	-145	-140	dBc/Hz
	100kHz	-164	-155	-140	dBc/Hz
	1MHz	-165	-165	-150	dBc/Hz

Environmental Compliance

Parameter	Conditions	Values			Unit
		MIN	TYP	MAX	
Operating Temperature	Option B	-20		+70	°C
	Option C	-40		+85	°C
	Option D	-55		+125	°C
Storage Temperature		-55		+125	°C
Solderability	MIL-STD-202 Method 208				
Shock	MIL-STD-202 Method 213 Test Condition A				
Vibration	MIL-STD-202 Method 204 Test Condition C				
Seal	MIL-STD-202 Method 112 Test Condition C & D				

Physical Specifications (Option 9)

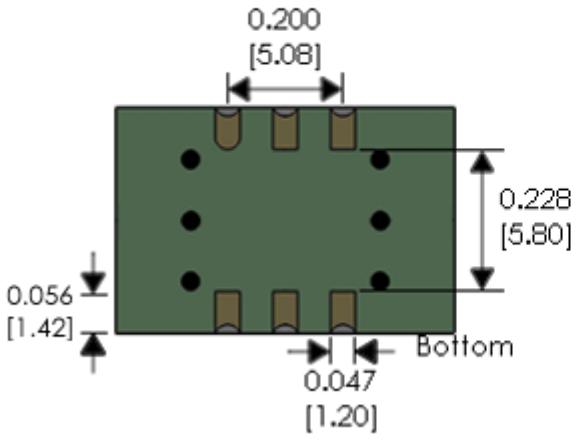
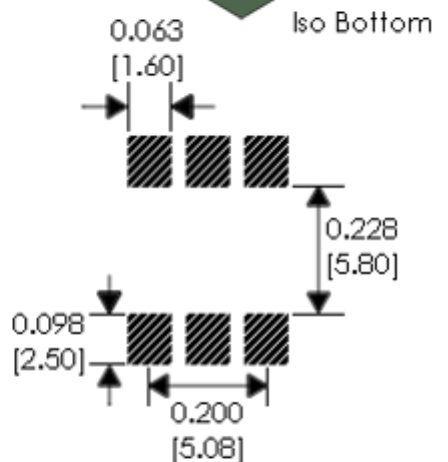
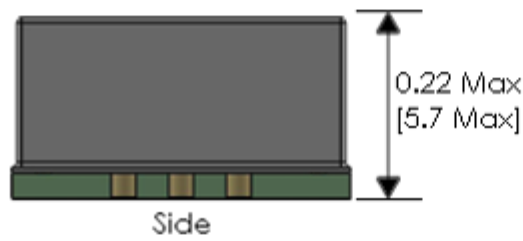
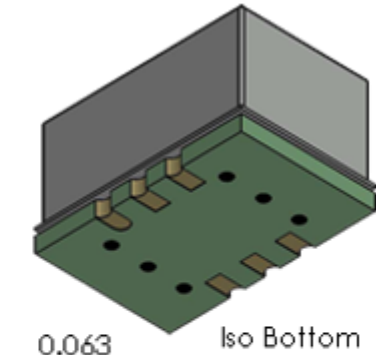
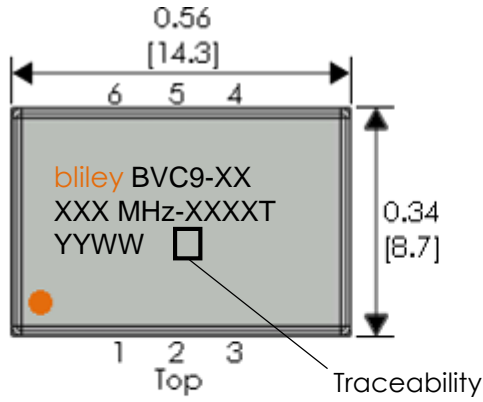

PIN	FUNCTION
1	EFC
2	Output Control
3	Ground
4	RF Output
5	N.C.
6	Supply Voltage

Tolerances (mm) .X = ± 0.5, .XX = ± 0.2 unless otherwise specified

Notes
1) None

DISCLAIMER: Bliley Technologies, Inc. reserves the right to make changes to the product(s) and or information contained herein without notice. No liability is assumed as a result of their use or application. No intellectual property rights accompany the sale or delivery of any such product(s) or information.

Physical Specifications (Option A)

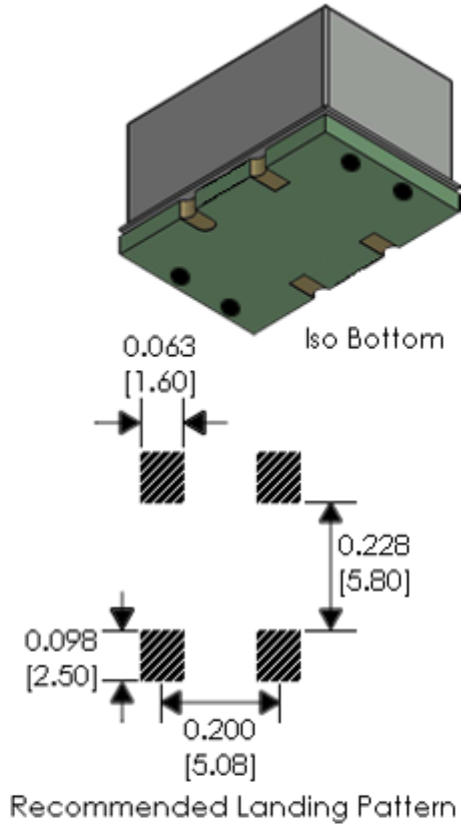
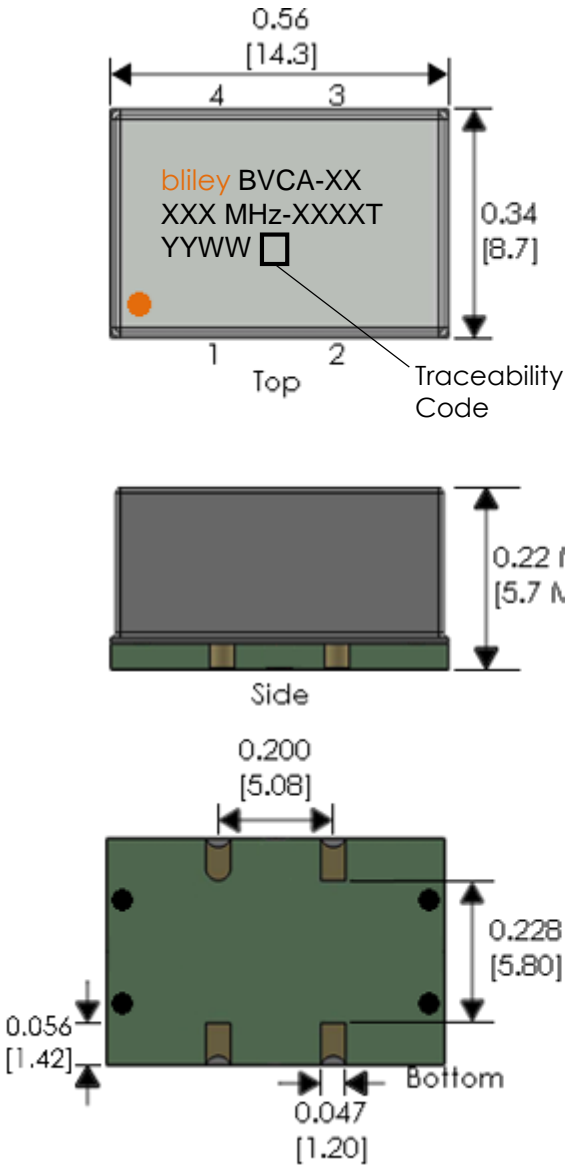

PIN	FUNCTION
1	EFC
2	Ground
3	RF Output
4	Supply Voltage

Tolerances (mm) .X = ± 0.5, .XX = ±0.2 unless otherwise specified

Notes
1) None

DISCLAIMER: Bliley Technologies, Inc. reserves the right to make changes to the product(s) and/or information contained herein without notice. No liability is assumed as a result of their use or application. No intellectual property rights accompany the sale or delivery of any such product(s) or information.

Tape and Reel

Embossed Carrier Dimensions (8mm, 12mm, 16mm, 24mm Tape Only)

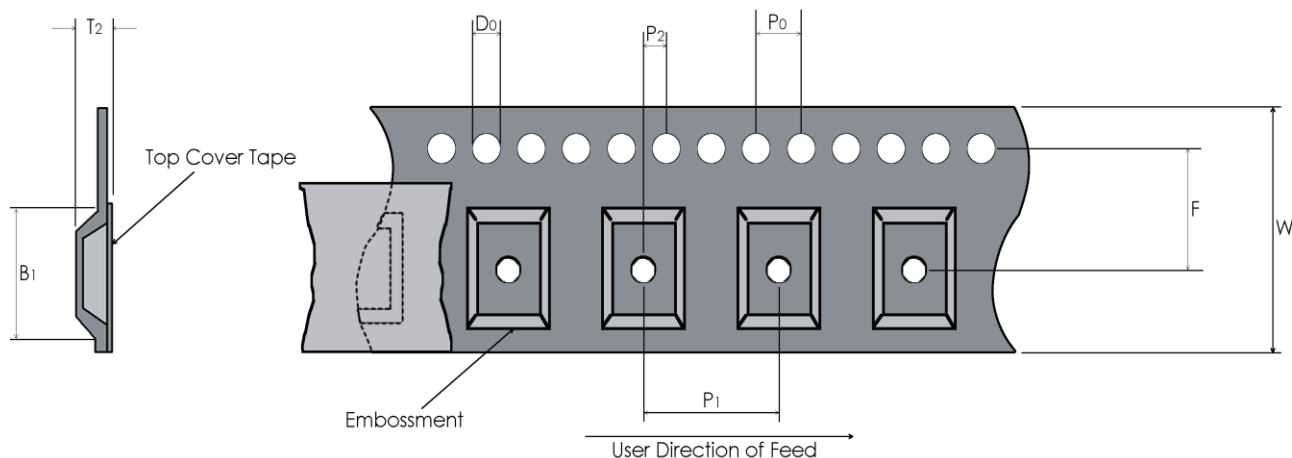

Tape Dimensions (mm)								Reel Dimensions (mm)	
W	F	Do	Po	P1	P2	B1	T2	Outside Dia.	Parts / Reel
24	11.5	1.5	4.0	12	2.0	15	8.8	330	1000

Recommended Reflow Profile

Reflow Profile: in accordance to IPC/JEDEC J-STD-020 (Latest Revision)

Additional Notes:

- This part has been designed for pick and place reflow soldering
- This part may be reflowed once
- This part should not be reflowed in the inverted position

Packaging

Packaging: All packaging must conform to ESD Controls detailed in ANSI/ESD S20.20 (Latest Revision)